

# Wilshire Steel Collection

Materials: **Weathering Steel or Mild Steel with Powder-coated finish**

Tournesol Siteworks' best-selling Wilshire planters, previously offered in FRP fiberglass and lightweight GFRG concrete, are now available in metal! Standard materials include weathering steel (Corten), a steel that rusts but maintains its structural strength, and powder-coated mild steel with a zinc-rich primer and stainless steel base.



- Wilshire steel planters feature fully-welded corners and stud-welded bulkhead construction for durability and rigidity
- Standard sizes available up to 8' L and 30" W x 30" H
- Fully engineered in 12 ga. material, designed to keep weight down and walls rigid
- Standard bottom-finish options include full skirt or with 2" toekick reveal



Weathering Steel, also known as Corten Steel, is delivered in a rustic mill-scale finish. The surface will slowly rust, yet retain its structural characteristics. For quicker aging, the surface may be sprayed in the field with a saline or acetic acid solution. Surface rust will begin appearing within a month of installation, and will be uneven depending on the nature of the mill-scale. The entire surface will eventually cover with rust. Rust is water-soluble, so it will leach and deposit on whatever surface the planter is on; leaching will typically stop after 9-12 months of in-field rusting. All weathering steel planters will have drain holes pre-installed.

### Wilshire Steel Collection - Weathering Steel Planters

Part. No.	Description	Planter Size	Weight (lbs.)	Soil Volume (cubic ft.)	Recommended Irrigation
WWR-WS241824	Wilshire weathering steel rectangular planter	24" L x 18" W x 24" H	86 lbs.	5.5	CWM-R2014-MS
WWR-WS361824	Wilshire weathering steel rectangular planter	36" L x 18" W x 24" H	115 lbs.	8	CWM-R2014-MS
WWR-WS481824	Wilshire weathering steel rectangular planter	48" L x 18" W x 24" H	148 lbs.	11	CWM-R2014-2k
WWR-WS601824	Wilshire weathering steel rectangular planter	60" L x 18" W x 24" H	177 lbs.	14	CWM-R2014-2k
WWR-WS721824	Wilshire weathering steel rectangular planter	72" L x 18" W x 24" H	210 lbs.	16.5	CWM-R2014-3k
WWR-WS961824	Wilshire weathering steel rectangular planter	96" L x 18" W x 24" H	267 lbs.	22	CWM-R2014-4k
WWR-WS362424	Wilshire weathering steel rectangular planter	36" L x 24" W x 24" H	132 lbs.	11	CWM-R2914-MS
WWR-WS482424	Wilshire weathering steel rectangular planter	48" L x 24" W x 24" H	169 lbs.	14.5	CWM-R2014-2k
WWR-WS602424	Wilshire weathering steel rectangular planter	60" L x 24" W x 24" H	200 lbs.	18.5	CWM-R2014-2k
WWR-WS722424	Wilshire weathering steel rectangular planter	72" L x 24" W x 24" H	238 lbs.	22	CWM-R2014-3k
WWR-WS962424	Wilshire weathering steel rectangular planter	96" L x 24" W x 24" H	299 lbs.	29.5	CWM-R2014-4k
WWR-WS363030	Wilshire weathering steel rectangular planter	36" L x 30" W x 30" H	173 lbs.	17.5	CWM-R2920-MS
WWR-WS483030	Wilshire weathering steel rectangular planter	48" L x 30" W x 30" H	219 lbs.	23.5	CWM-R2020-2k
WWR-WS603030	Wilshire weathering steel rectangular planter	60" L x 30" W x 30" H	256 lbs.	29	CWM-R2020-2k
WWR-WS723030	Wilshire weathering steel rectangular planter	72" L x 30" W x 30" H	301 lbs.	35	CWM-R2020-3k
WWR-WS963030	Wilshire weathering steel rectangular planter	96" L x 30" W x 30" H	375 lbs.	46.5	CWM-R2020-4k
WWR-WS2400	Wilshire weathering steel square planter	24" L x 24" W x 24" H	106 lbs.	7.5	CWC-R1850/CWM-R1120-2k
WWR-WS3000	Wilshire weathering steel square planter	30" L x 30" W x 27" H	150 lbs.	13	CWM-R2020-2k
WWR-WS3600	Wilshire weathering steel square planter	36" L x 36" W x 30" H	204 lbs.	21	CWM-R2920-2k
WWR-WS4800	Wilshire weathering steel square planter	48" L x 48" W x 36" H	344 lbs.	45.5	CWM-R2920-2k

Part. No.	Base Options for Wilshire Collection Weathering Steel Planters
WWR-RE	Full toekick - 2" bottom reveal for Wilshire weathering steel square and rectangular planters
WWR-SK	Full wall - no toekick/reveal for Wilshire weathering steel square and rectangular planters

Each weathering steel planter has a rustic, untreated finish.

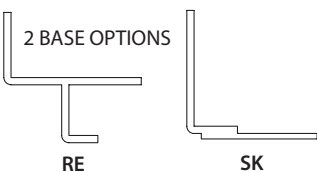

Wilshire steel planters are available with most of the same planter options as FRP or GFRC concrete planters, including scoops, custom accessory pockets, casters, etc. Ask your salesperson for details.

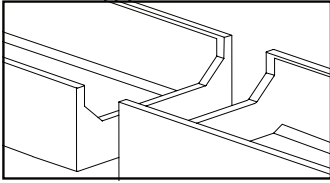

Scoop for connecting multiple individual modular units

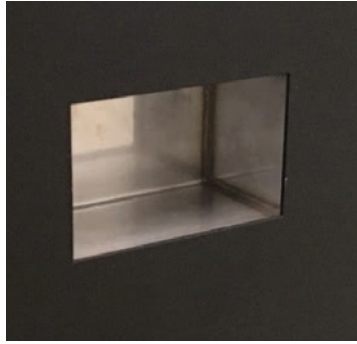

Optional Accessory Pockets



Mild steel planters are zinc-primed then powder-coated to help prevent rusting. An unfinished stainless steel bottom with drain holes is installed to prevent rust on the base of the planter. Custom powder-coat colors and finishes are available.

### Wilshire Steel Collection - Mild Steel Planters with Powder-coated Finish

Part. No.	Description	Planter Size	Weight (lbs.)	Soil Volume (cubic ft.)	Recommended Irrigation
WWR-CS241824	Wilshire powder-coated steel rectangular planter	24" L x 18" W x 24" H	86 lbs.	5.5	CWM-R2014-MS
WWR-CS361824	Wilshire powder-coated steel rectangular planter	36" L x 18" W x 24" H	115 lbs.	8	CWM-R2014-MS
WWR-CS481824	Wilshire powder-coated steel rectangular planter	48" L x 18" W x 24" H	148 lbs.	11	CWM-R2014-2k
WWR-CS601824	Wilshire powder-coated steel rectangular planter	60" L x 18" W x 24" H	177 lbs.	14	CWM-R2014-2k
WWR-CS721824	Wilshire powder-coated steel rectangular planter	72" L x 18" W x 24" H	210 lbs.	16.5	CWM-R2014-3k
WWR-CS961824	Wilshire powder-coated steel rectangular planter	96" L x 18" W x 24" H	267 lbs.	22	CWM-R2014-4k
WWR-CS362424	Wilshire powder-coated steel rectangular planter	36" L x 24" W x 24" H	132 lbs.	11	CWM-R2914-MS
WWR-CS482424	Wilshire powder-coated steel rectangular planter	48" L x 24" W x 24" H	169 lbs.	14.5	CWM-R2014-2k
WWR-CS602424	Wilshire powder-coated steel rectangular planter	60" L x 24" W x 24" H	200 lbs.	18.5	CWM-R2014-2k
WWR-CS722424	Wilshire powder-coated steel rectangular planter	72" L x 24" W x 24" H	238 lbs.	22	CWM-R2014-3k
WWR-CS962424	Wilshire powder-coated steel rectangular planter	96" L x 24" W x 24" H	299 lbs.	29.5	CWM-R2014-4k
WWR-CS363030	Wilshire powder-coated steel rectangular planter	36" L x 30" W x 30" H	173 lbs.	17.5	CWM-R2920-MS
WWR-CS483030	Wilshire powder-coated steel rectangular planter	48" L x 30" W x 30" H	219 lbs.	23.5	CWM-R2020-2k
WWR-CS603030	Wilshire powder-coated steel rectangular planter	60" L x 30" W x 30" H	256 lbs.	29	CWM-R2020-2k
WWR-CS723030	Wilshire powder-coated steel rectangular planter	72" L x 30" W x 30" H	301 lbs.	35	CWM-R2020-3k
WWR-CS963030	Wilshire powder-coated steel rectangular planter	96" L x 30" W x 30" H	375 lbs.	46.5	CWM-R2020-4k
WWR-CS2400	Wilshire powder-coated steel square planter	24" L x 24" W x 24" H	106 lbs.	7.5	CWC-R1850/CWM-R1 120-2k
WWR-CS3000	Wilshire powder-coated steel square planter	30" L x 30" W x 27" H	150 lbs.	13	CWM-R2020-2k
WWR-CS3600	Wilshire powder-coated steel square planter	36" L x 36" W x 30" H	204 lbs.	21	CWM-R2920-2k
WWR-CS4800	Wilshire powder-coated steel square planter	48" L x 48" W x 36" H	344 lbs.	45.5	CWM-R2920-2k

Part. No.	Base Options for Wilshire Collection Steel Planters
WWR-RE	Full toekick - 2" bottom reveal for Wilshire steel square and rectangular planters
WWR-SK	Full wall – no toekick/reveal for Wilshire steel square and rectangular planters

The mild steel planter will have a powder-coated finish, with an unfinished stainless steel bottom.

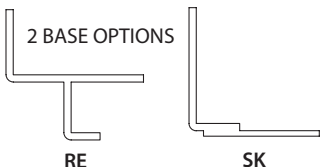

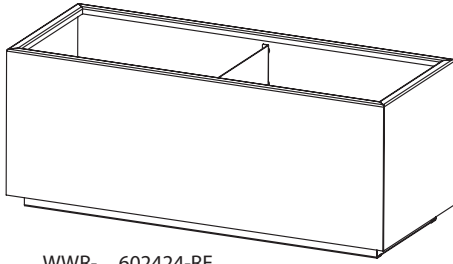

WWR-\_\_602424-RE

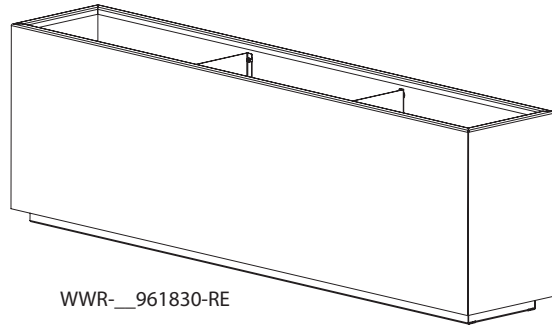

WWR-\_\_961830-RE

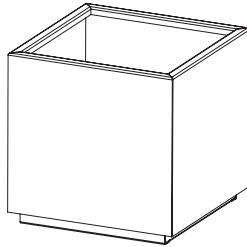

WWR-\_\_2400-RE

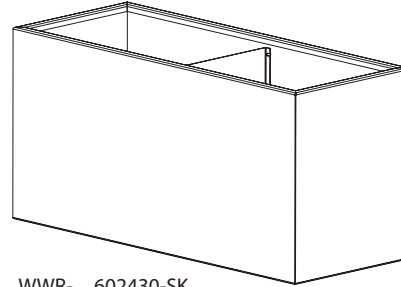

WWR-\_\_602430-SK

Base Options - available as standard on any Wilshire steel planter. Please specify at time of order.

- Full toekick – a 2" bottom reveal which visually lightens the mass.
- Full wall – no toekick/reveal for Wilshire steel rectangular planters.

#### Properties of Weathering Steel

- Planters are shipped with rustic mill-scale finish. They may begin to rust in transit. Initial rust patina develops within weeks, complete rusting may take years to develop.
- Exact finish and rate of rust patina formation varies greatly based on environmental conditions at the installation location.
- Some environmental conditions will hasten the weathering steel process causing accelerated rusting (e.g. salt and/or sub-tropical climate, animal urine, etc).
- Rust staining will likely occur on any surface the planter is on, as well as any path that rain runoff follows, and any gutter/ drain system near the planter. This will lessen over time.
- Exact color of patina will change over time from a vibrant orange to a darker brown color.



Custom Wilshire Weathering Steel

PRODUCT & PRICING INFO

