

Plaza Collection

Classic Benches, Tables, Receptacles and Recyclers

Materials: **Mild Steel**

With classic beauty and durability, our Plaza Collection offers a selection of steel strap benches to blend in various environments. All Plaza Benches are fabricated with steel straps and offer a range of end frame construction, backed or backless benches with vertical or horizontal straps. The Plaza Collection also features complementary trash or ash receptacles, and picnic tables.



PZ-01C00-72 with Custom Endframe and Plaque



Plaza Benches - PZ-0100-72



PZ-075D-30



PZ-01C00-72

- Strong 1/4 x 1-1/2" steel strap seats, fully welded 1" solid bar or cast end frame holds up to intense traffic.
- These commercial grade benches are comfortable, strong and durable.
- Plaza benches can be matched with trash or ash receptacles, and picnic tables.
- Collection has several complementary seating designs to meet specific project needs.



PZ-01XH00-72



PZ-01H00-72

Plaza Collection

Specifications

Part. No.	Description	Size (L x W x H)	Seat Height	Weight Lbs.	Mounting
PZ-0100-48	Plaza Steel Bench w/ Back & Arms (PL-3)	48-3/4" x 26-7/8" x 33-5/8"	16"	160	Surface-mount
PZ-0100-60	Plaza Steel Bench w/ Back & Arms	60-3/4" x 26-7/8" x 33-5/8"	16"	190	Surface-mount
PZ-0100-72	Plaza Steel Bench w/ Back & Arms	72-3/4" x 26-7/8" x 33-5/8"	16"	223	Surface-mount
PZ-0100-96	Plaza Steel Bench w/ Back & Arms	96-3/4" x 26-7/8" x 33-5/8"	16"	278	Surface-mount
PZ-CA	Option: Center Arm			10	
PZ-CFA	Option: Center Frame with/ Arm			55	
PZ-01H00-48	Plaza Steel Bench w/ Back, horizontal seat (PL-3H)	48-3/4" x 28" x 34"	16-3/4"	213	Surface-mount
PZ-01H00-60	Plaza Steel Bench w/ Back, horizontal seat	60-3/4" x 28" x 34"	16-3/4"	248	Surface-mount
PZ-01H00-72	Plaza Steel Bench w/ Back, horizontal seat	72-3/4" x 28" x 34"	16-3/4"	291	Surface-mount
PZ-01H00-96	Plaza Steel Bench w/ Back, horizontal seat	96-3/4" x 28" x 34"	16-3/4"	330	Surface-mount
PZ-01X00-48	Plaza Steel & Cast Iron Bench w/ Back & Arms (PL-4)	49-1/4" x 27-1/4" x 33-1/2"	16-1/2"	283	Surface-mount
PZ-01X00-60	Plaza Steel & Cast Iron Bench w/ Back & Arms	61-1/4" x 27-1/4" x 33-1/2"	16-1/2"	323	Surface-mount
PZ-01X00-72	Plaza Steel & Cast Iron Bench w/ Back & Arms	73-1/4" x 27-1/4" x 33-1/2"	16-1/2"	364	Surface-mount
PZ-01X00-96	Plaza Steel & Cast Iron Bench w/ Back & Arms	97-1/4" x 27-1/4" x 33-1/2"	16-1/2"	449	Surface-mount
PZ-CA	Option: Center Arm			10	
PZ-CFA	Option: Center Frame with/ Arm			55	
PZ-01XH00-48	Plaza Steel & Cast Iron Bench w/ Back & Arms, horiz seat (PL-4H)	49-1/4" x 27-1/4" x 33-1/2"	16-1/2"	283	Surface-mount
PZ-01XH00-60	Plaza Steel & Cast Iron Bench w/ Back & Arms, horizontal seat	61-1/4" x 27-1/4" x 33-1/2"	16-1/2"	323	Surface-mount
PZ-01XH00-72	Plaza Steel & Cast Iron Bench w/ Back & Arms, horizontal seat	73-1/4" x 27-1/4" x 33-1/2"	16-1/2"	364	Surface-mount
PZ-01XH00-96	Plaza Steel & Cast Iron Bench w/ Back & Arms, horizontal seat	97-1/4" x 27-1/4" x 33-1/2"	16-1/2"	449	Surface-mount
PZ-01C00-48	Plaza Steel & Cast Iron Bench w/ Back & Arms (PL-5)	49-1/4" x 27-1/4" x 33-1/2"	16-1/2"	283	Surface-mount
PZ-01C00-60	Plaza Steel & Cast Iron Bench w/ Back & Arms	61-1/4" x 27-1/4" x 33-1/2"	16-1/2"	323	Surface-mount
PZ-01C00-72	Plaza Steel & Cast Iron Bench w/ Back & Arms	73-1/4" x 27-1/4" x 33-1/2"	16-1/2"	364	Surface-mount
PZ-01C00-96	Plaza Steel & Cast Iron Bench w/ Back & Arms	97-1/4" x 27-1/4" x 33-1/2"	16-1/2"	449	Surface-mount
PZ-CA	Option: Center Arm			10	
PZ-CFA	Option: Center Frame with/ Arm			55	

*Plaza Collection benches are available in 48", 60", 72" and 96" lengths. Many are available with optional center arms or center frames.

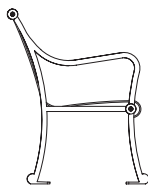

PZ-0100

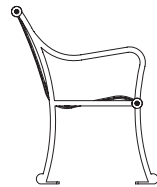

PZ-01H00

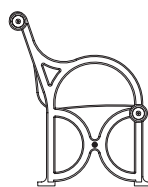

PZ-01X00

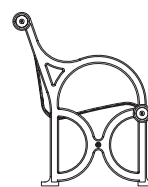

PZ-01XH00

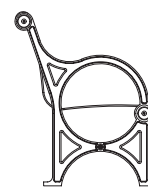

PZ-01C00



PZ-01C00-96/w PZ-01CA



PZ-200-72



PZ-0300-72

Plaza Collection

Specifications

Part. No.	Description	Size (L x W x H)	Seat Height	Weight Lbs.	Mounting
PZ-01CH00-48	Plaza Steel & Cast Iron Bench w/ Back & Arms, horiz seat (PL-5H)	49-1/4" x 27-1/4" x 33-1/2"	16-1/2"	283	Surface-mount
PZ-01CH00-60	Plaza Steel & Cast Iron Bench w/ Back & Arms, horizontal seat	61-1/4" x 27-1/4" x 33-1/2"	16-1/2"	323	Surface-mount
PZ-01CH00-72	Plaza Steel & Cast Iron Bench w/ Back & Arms, horizontal seat	73-1/4" x 27-1/4" x 33-1/2"	16-1/2"	364	Surface-mount
PZ-01CH00-96	Plaza Steel & Cast Iron Bench w/ Back & Arms, horizontal seat	97-1/4" x 27-1/4" x 33-1/2"	16-1/2"	449	Surface-mount
PZ-0200-48	Plaza Steel Bench w/ Back (PL-2)	47" x 26" x 35-5/8"	16-3/4"	208	Surface-mount
PZ-0220-48	Plaza Steel Bench w/ Back	47" x 26" x 35-5/8"	16-3/4"	208	Embed
PZ-0200-60	Plaza Steel Bench w/ Back	58-1/2" x 26" x 35-5/8"	16-3/4"	241	Surface-mount
PZ-0220-60	Plaza Steel Bench w/ Back	58-1/2" x 26" x 35-5/8"	16-3/4"	241	Embed
PZ-0200-72	Plaza Steel Bench w/ Back	71-3/8" x 26" x 35-5/8"	16-3/4"	274	Surface-mount
PZ-0220-72	Plaza Steel Bench w/ Back	71-3/8" x 26" x 35-5/8"	16-3/4"	274	Embed
PZ-0200-96	Plaza Steel Bench w/ Back	95-3/8" x 26" x 35-5/8"	16-3/4"	340	Surface-mount
PZ-0220-96	Plaza Steel Bench w/ Back	95-3/8" x 26" x 35-5/8"	16-3/4"	340	Embed
PZ-02A	Option: Arms (each) for PZ-02 backed benches			10	
PZ-0300-48	Plaza Steel Backless Bench with Arms (PL-1.3)	48-3/4" x 23-1/2" x 21"	16-1/2"	169	Surface-mount
PZ-0300-60	Plaza Steel Backless Bench with Arms	60-3/4" x 23-1/2" x 21"	16-1/2"	195	Surface-mount
PZ-0300-72	Plaza Steel Backless Bench with Arms	72-3/4" x 23-1/2" x 21"	16-1/2"	216	Surface-mount
PZ-0300-96	Plaza Steel Backless Bench with Arms	96-3/4" x 23-1/2" x 21"	16-1/2"	298	Surface-mount
PZ-CFA	Option: Center Frame with/ Arm			10	

*Plaza Collection benches are available in 48", 60", 72" and 96" lengths. Many are available with optional center arms or center frames.

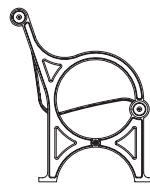

PZ-01CH00



PZ-0200

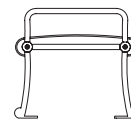

PZ-0300



Plaza Collection

Specifications

Part. No.	Description	Size (L x W x H)	Seat Height	Weight Lbs.	Mounting
PZ-03H00-48	Plaza Steel Backless Bench with Arms, horiz seat (PL-1.3H)	48-3/4" x 23-1/8" x 22"	16-1/4"	169	Surface-mount
PZ-03H00-60	Plaza Steel Backless Bench with Arms, horizontal seat	60-3/4" x 23-1/8" x 22"	16-1/4"	195	Surface-mount
PZ-03H00-72	Plaza Steel Backless Bench with Arms, horizontal seat	72-3/4" x 23-1/8" x 22"	16-1/4"	216	Surface-mount
PZ-03H00-96	Plaza Steel Backless Bench with Arms, horizontal seat	96-3/4" x 23-1/8" x 22"	16-1/4"	298	Surface-mount
PZ-AR	Option: Center Arm for backless bench			10	
PZ-03C00-48	Plaza Steel and Cast Iron Backless Bench w/Arms (PL-1.5)	49-1/4" x 22" x 26"	17"	230	Surface-mount
PZ-03C00-60	Plaza Steel and Cast Iron Backless Bench w/Arms	61-1/4" x 22" x 26"	17"	252	Surface-mount
PZ-03C00-72	Plaza Steel and Cast Iron Backless Bench w/Arms	73-1/4" x 22" x 26"	17"	275	Surface-mount
PZ-03C00-96	Plaza Steel and Cast Iron Backless Bench w/Arms	97-1/4" x 22" x 26"	17"	321	Surface-mount
PZ-CA	Option: Center Arm			10	
PZ-CFA	Option: Center Frame with/ Arm			55	
PZ-0400-48	Plaza Steel Backless Bench (PL-1)	47" x 18-1/2" x 16-1/2"	16-1/2"	160	Surface-mount
PZ-0420-48	Plaza Steel Backless Bench	47" x 18-1/2" x 16-1/2"	16-1/2"	160	Embed
PZ-0400-60	Plaza Steel Backless Bench	58-1/2" x 18-1/2" x 16-1/2"	16-1/2"	190	Surface-mount
PZ-0420-60	Plaza Steel Backless Bench	58-1/2" x 18-1/2" x 16-1/2"	16-1/2"	190	Embed
PZ-0400-72	Plaza Steel Backless Bench	70-3/8" x 18-1/2" x 16-1/2"	16-1/2"	223	Surface-mount
PZ-0420-72	Plaza Steel Backless Bench	70-3/8" x 18-1/2" x 16-1/2"	16-1/2"	223	Embed
PZ-0400-96	Plaza Steel Backless Bench	95-3/8" x 18-1/2" x 16-1/2"	16-1/2"	278	Surface-mount
PZ-0420-96	Plaza Steel Backless Bench	95-3/8" x 18-1/2" x 16-1/2"	16-1/2"	278	Embed
PZ-AR	Option: Center Arm			10	

*Plaza Collection benches are available in 48", 60", 72" and 96" lengths. Many are available with optional center arms or center frames.

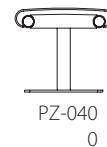
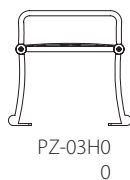

Ask about our custom branding options. From inlaid sponsor plaques on seat sections to custom laser-cut logos on bench end frames and on trash receptacles, the Plaza Collection offers a variety of options for specific applications. Ask your Tournesol Siteworks salesperson for details.



PZ-04S00-72



PZ-01X00-72

Plaza Collection

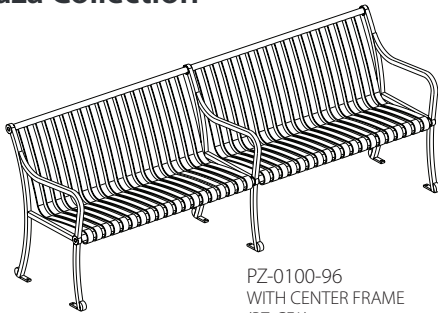

PZ-0100-96
WITH CENTER FRAME
(PZ-CFA)

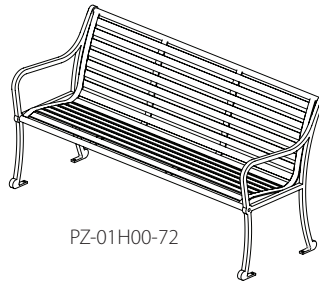

PZ-01H00-72

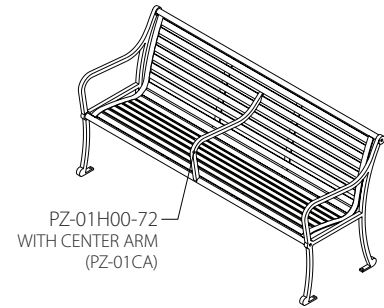

PZ-01H00-72
WITH CENTER ARM
(PZ-01CA)



PZ-0100-60

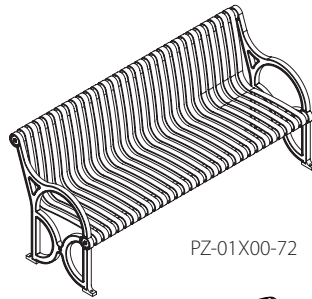

PZ-01X00-72



PZ-01C00-96
WITH CENTER FRAME
(PZ-CFA)

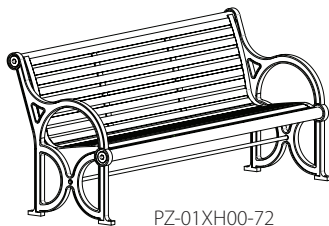

PZ-01XH00-72

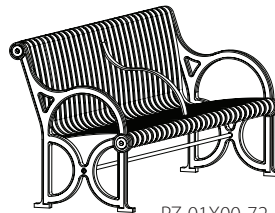

PZ-01X00-72
WITH CENTER ARM
(PZ-CA)

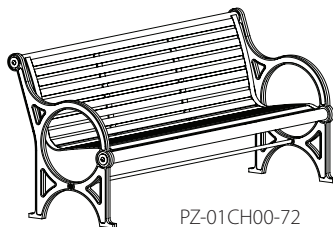

PZ-01CH00-72

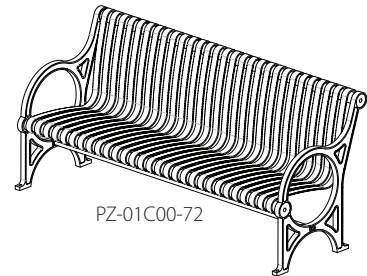

PZ-01C00-72

*Plaza Collection benches are available in 48", 60", 72" and 96" lengths. Many are available with optional center arms or center frames. See the Plaza Collection Trash and Ash Receptacle detail sheet for more complementary options.

Ask about our custom branding options. From inlaid sponsor plaques on seat sections to custom laser-cut logos on bench end frames and on trash receptacles, the Plaza Collection offers a variety of options for specific applications. Ask your Tournesol Siteworks salesperson for details.



PZ-0400-72 Custom Curved



PZ-01C00-72 WITH CENTER FRAME

Plaza Collection

Plaza Benches are shown with standard surface-mount bases. Some are available with permanent embed mounting. Arms can be added to further define individual seats.

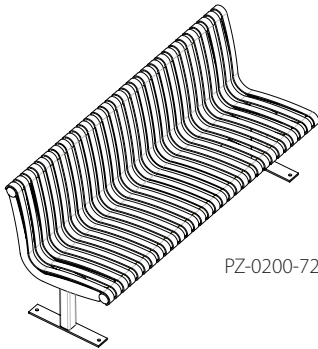

PZ-0200-72

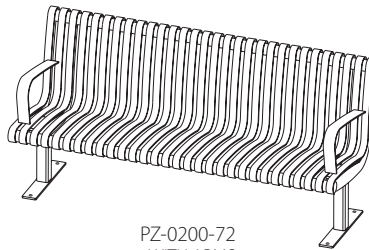

PZ-0200-72 WITH ARMS (PZ-02A x2)

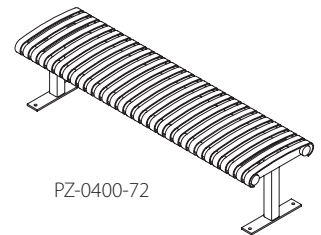

PZ-0400-72

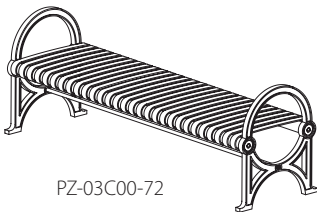

PZ-03C00-72

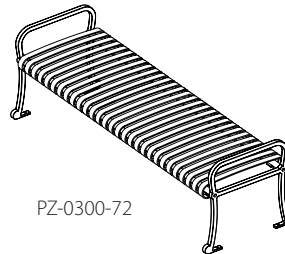

PZ-0300-72

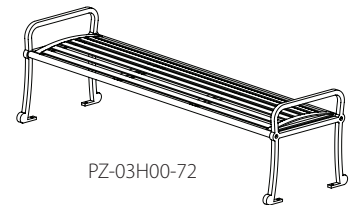

PZ-03H00-72



PZ-03C00-72

Plaza Collection benches are available in 48", 60", 72" and 96" lengths. Many are available with optional center arms or center frames. See the Plaza Collection Trash and Ash Receptacle detail sheet for more complementary options.

Ask about our custom branding options. From inlaid sponsor plaques on seat sections to custom laser-cut logos on bench end frames and on trash receptacles, the Plaza Collection offers a variety of options for specific applications. Ask your Tournesol Siteworks salesperson for details.



Plaza Trash Receptacles and Recyclers

Plaza Collection receptacles provide an attractive solution to litter control in public places. The flared top trash receptacles are fabricated with 1-1/2" steel straps and simple clean lines to match the Plaza benches. Plaza Collection receptacles come in many decorative configurations, and may feature hinged side-opening doors, rain shield tops, or pedestal bases. Ask your Tournesol Siteworks salesperson for details.



Complementary Plaza Ash Receptacles



Plaza Collection also includes complementary Plaza tables available in 37" square top tables or 6' to 8' rectangular tables. Many are available with optional surface and embed styles. See the Plaza Collection tables detail sheet for more complementary options.

Ask about our custom branding options. From inlaid sponsor plaques on seat sections to custom laser-cut logos on bench end frames and on trash receptacles, the Plaza Collection offers a variety of options for specific applications. Ask your Tournesol Siteworks salesperson for details.

PRODUCT & PRICING INFO
STREETSCAPES
 303.398.7040 STREET-SCAPES.COM

 **Tournesol** SITEWORKS