



UNIVERSAL LITTER & RECYCLING RECEPTACLE

PRODUCT DATA



PRODUCT & PRICING INFO

STREETSCAPES
303.398.7040 STREET-SCAPES.COM

FORMS+SURFACES®



UNIVERSAL LITTER & RECYCLING RECEPTACLE

PRODUCT DATA

Blending unparalleled design flexibility with real-world functionality, **Universal Litter & Recycling Receptacles** offer the beauty and performance of stainless steel in a comprehensive range of sizes, configurations, and design options. Universal's highly adaptable format gives you the freedom to tailor receptacles to project-specific conditions. High-durability finishes and beautiful decorative patterns make it easy to create a striking visual statement. Top- and side-opening models, 12-36-gallon capacities, and single- and split-stream variations allow you to address a diversity of needs. At home indoors or out, Universal is a premier choice for airports, malls, universities, healthcare facilities, office buildings, and other public spaces.

MATERIAL & CONSTRUCTION DETAILS

INSTALLATION & MAINTENANCE

CONFIGURATIONS	BODY MATERIALS & FINISHES	BODY PATTERNS	INSTALLATION
<ul style="list-style-type: none"> • Universal Receptacles are available in top- and side-opening configurations with 36-, 30-, 24-, and 12-gallon capacities. • Top-opening configurations have the same number of liners as lid openings. • Side-opening configurations can be specified with one full liner or two half liners with an internal baffle. 	<ul style="list-style-type: none"> • Stainless Steel with Sandstone, Seastone, Linen, Diamond, or Satin finish are available for all Universal Receptacles. • Fused Bronze and Fused Nickel Silver bodies with Sandstone, Seastone, and Diamond finishes are available on 12-gallon receptacles for an upcharge. 	<ul style="list-style-type: none"> • Eight different body patterns are available for an upcharge; see pages 8 and 9 for standard patterns. • Eco-Etch designs are applied using an advanced photolithographic bead-blasting system. • Impression designs have stamped, high-relief patterns. • Perforation patterns offer unique designs. 	<ul style="list-style-type: none"> • Universal Receptacles may be used freestanding or surface mounted. • Anchors, levelers, and stainless steel mounting screws are provided when surface mounting is specified; levelers are supplied for all polyethylene base receptacles.
LIDS	GRAPHICS	BASES	MAINTENANCE
<ul style="list-style-type: none"> • Standard lids for 36-, 24-, and 12-gallon receptacles are molded from polyethylene with a UL94HB fire rating, and are slate-colored with a light texture. • Top-opening lids for 36-, 24-, and 12-gallon receptacles with 10" and 7" diameter openings are available in Stainless Steel with a Satin finish for an upcharge. • Standard lids for 30-gallon receptacles are available in Stainless Steel only. • Concealed ash lids in Stainless Steel with Satin finish are available for 12-gallon, side-opening receptacles. • Tether cables are available to connect receptacle lid to body. 	<ul style="list-style-type: none"> • Instructional graphics are available with a variety of standard messages that clearly indicate the use for each opening. • Graphics have white letters and symbols with black, blue, or green backgrounds. • Graphics are printed on the back of clear, lightly textured polycarbonate, protecting them from wear over time. 	<ul style="list-style-type: none"> • Standard 1.5" high tapered bases are molded from polyethylene with a UL94HB fire rating and are slate-colored with a light texture. • TENSL ultra high performance concrete (UHPC) bases are available on 36-, 30-, and 24-gallon Universal Receptacles for an upcharge. 	<ul style="list-style-type: none"> • Polyethylene, TENSL UHPC, and metal surfaces can be cleaned as needed using a soft cloth or brush with warm water and a mild detergent. Avoid abrasive cleaners. • Use caution when cleaning over graphics.



UNIVERSAL LITTER & RECYCLING RECEPTACLE

PRODUCT DATA

36-GALLON NOMINAL DIMENSIONS

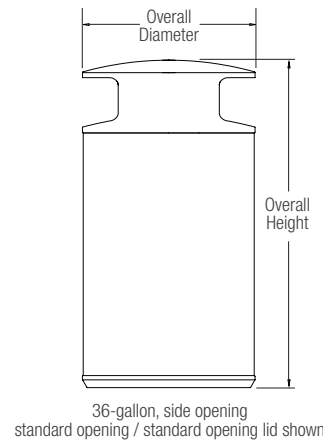
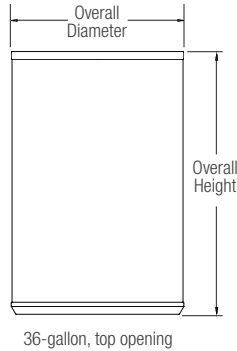

MODELS	OVERALL DIAMETER	OVERALL HEIGHT*	OVERALL WEIGHT
36-gallon, top opening	21.4" (544 mm)	32.7" (831 mm)	49 lbs (22 kg)
36-gallon, side opening	21.5" (546 mm)	40.8" (1,036 mm)	52 lbs (24 kg)

*NOTE: TENSL UHPC base adds 3" to overall height.

36-GALLON, TOP-OPENING LIDS

CONFIGURATION	10" Diameter Opening*	6" Diameter Opening	Split-Stream	Tri-Stream	Paper Slot
TOP VIEW					
SIDE VIEW					
OPENING(S)	10"	6"	(2) 14.0" x 6.2"	(1) 14.0" x 6.2" (2) 5.8" x 5.8"	13" x 2.5"

*Top opening, 10" diameter opening is available in both polyethylene and stainless steel with Satin finish.

36-GALLON, SIDE-OPENING LIDS

CONFIGURATION	Standard Opening / Standard Opening	Standard Opening / Round Opening	Round Opening / Round Opening
TOP VIEW			
SIDE VIEW			
OPENINGS	(2) 17.1" x 6.0"	(1) 17.1" x 6.0" / (1) 7.6" x 6.5"	(2) 7.6" x 6.5"



UNIVERSAL LITTER & RECYCLING RECEPTACLE

PRODUCT DATA

30-GALLON NOMINAL DIMENSIONS

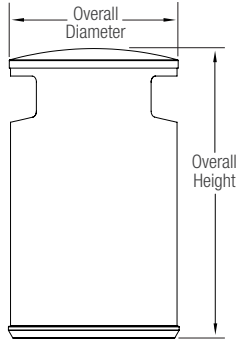

30-gallon, side opening, standard opening (front view)

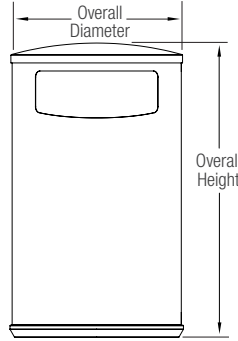

30-gallon, side opening, standard opening (right view)

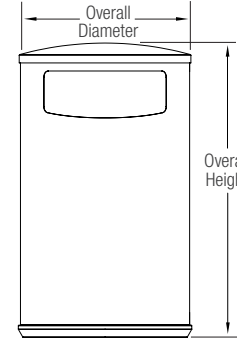

30-gallon, side opening, standard opening (left view)

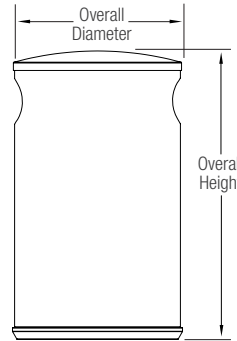

30-gallon, side opening, round opening (front view)

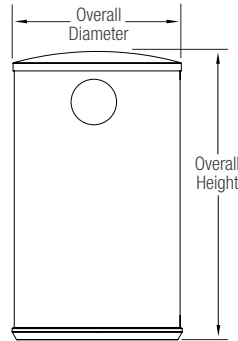

30-gallon, side opening, round opening (right view)

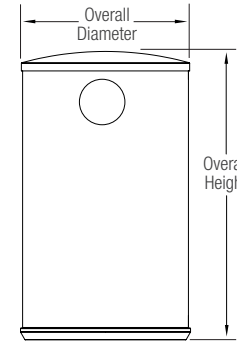

30-gallon, side opening, round opening (left view)

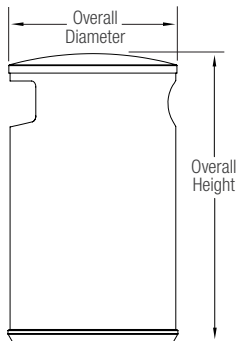

30-gallon, side opening, standard opening, round opening (side view)

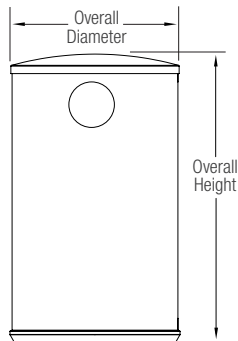

30-gallon, side opening, standard opening, round opening (right view)

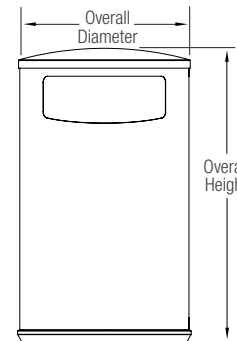

30-gallon, side opening, standard opening (left view)

MODEL	OVERALL DIAMETER	OVERALL HEIGHT*	OVERALL WEIGHT
30-gallon, side opening	21.5" (546 mm)	37.5" (953 mm)	50 lbs (23 kg)

*NOTE: TENSL UHPC base adds 3" to overall height.



UNIVERSAL LITTER & RECYCLING RECEPTACLE

PRODUCT DATA

24-GALLON NOMINAL DIMENSIONS

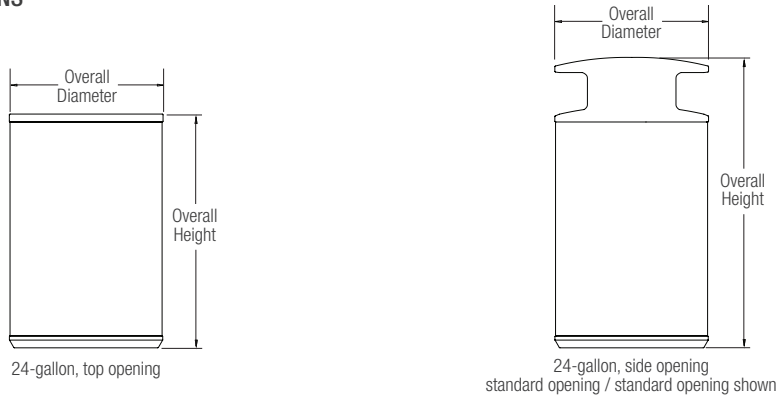

MODELS	OVERALL DIAMETER	OVERALL HEIGHT*	OVERALL WEIGHT
24-gallon, top opening	19.4" (493 mm)	29.5" (749 mm)	42 lbs (19 kg)
24-gallon, side opening	19.4" (493 mm)	37.3" (947 mm)	45 lbs (20 kg)

*NOTE: TENSL UHPC base adds 3" to overall height.

24-GALLON, TOP-OPENING LIDS

CONFIGURATION	10" Diameter Opening*	6" Diameter Opening	Split-Stream	Paper Slot
TOP VIEW				
SIDE VIEW				
OPENING(S)	10"	6"	(2) 4.9" x 11.1"	12"

*Top opening, 10" diameter opening is available in both polyethylene and stainless steel with Satin finish.

24-GALLON, SIDE-OPENING LIDS

CONFIGURATION	Standard Opening / Standard Opening	Standard Opening / Round Opening	Round Opening / Round Opening
TOP VIEW			
SIDE VIEW			
OPENINGS	(2) 15.9" x 5.3"	(1) 15.9" x 5.3" / (1) 7.3" x 6.3"	(2) 7.3" x 6.3"



UNIVERSAL LITTER & RECYCLING RECEPTACLE

PRODUCT DATA

12-GALLON NOMINAL DIMENSIONS

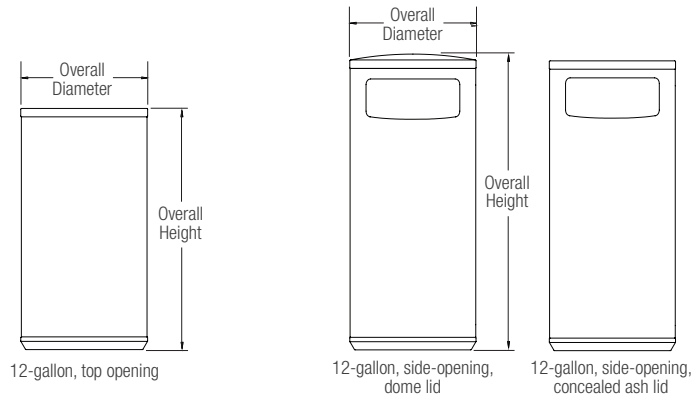

MODELS	OVERALL DIAMETER	OVERALL HEIGHT	OVERALL WEIGHT
12-gallon, top opening	15.1" (384 mm)	29.5" (749 mm)	25 lbs (11 kg)
12-gallon, side opening	15.1" (384 mm)	36.2" (919 mm) (35.5" concealed ash lid)	27 lbs (12 kg)

12-GALLON, TOP-OPENING LIDS

CONFIGURATION	7" Diameter Opening*	Split-Stream
TOP VIEW		
SIDE VIEW		
OPENING(S)	7"	(2) 4.7" x 10.6"

12-GALLON, SIDE-OPENING LIDS

CONFIGURATION	Dome Lid	Concealed Ash Lid**
TOP VIEW		
SIDE VIEW		
OPENINGS IN BODY (see top of page)	(2) 11.0" x 4.9"	(2) 11.0" x 4.9" (5" ash opening in lid)

*Top opening, 7" diameter opening is available in both polyethylene and stainless steel with Satin finish.

**Concealed ash lid is available in stainless steel with Satin finish only.



UNIVERSAL LITTER & RECYCLING RECEPTACLE

PRODUCT DATA

LID MATERIALS

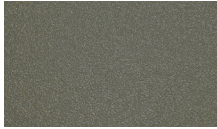

POLYETHYLENE, SLATE

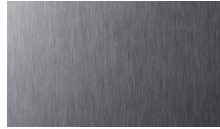

STAINLESS STEEL, SATIN*

STANDARD GRAPHICS

All graphics are available with black backgrounds. Recycling, bottles & cans, paper, and compost graphics are also available with blue or green backgrounds to clearly indicate recycling streams. All letters and symbols are white.

TOP-OPENING GRAPHICS



SIDE-OPENING GRAPHICS

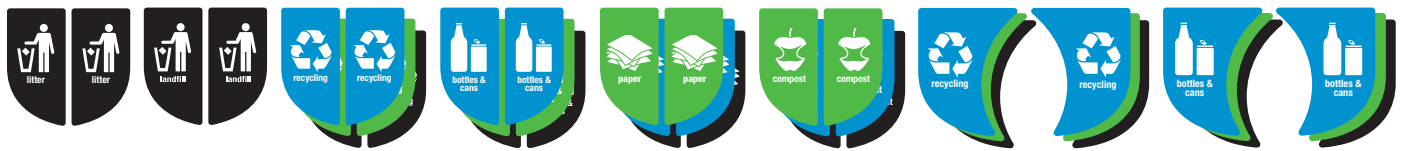

BODY MATERIALS & FINISHES

Bodies are available in a variety of distinctive finishes including standard and High-Durability options. High-Durability finishes, designated by the "HD" logo below, are manufactured in a process that creates a work-hardened surface with enhanced resistance to abrasion and wear.



STAINLESS STEEL,
SANDSTONE



STAINLESS STEEL,
SEASTONE



STAINLESS STEEL,
LINEN

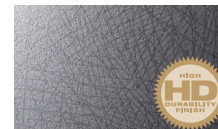

STAINLESS STEEL,
DIAMOND

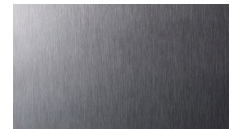

STAINLESS STEEL,
SATIN

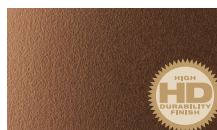

**FUSED BRONZE,
SANDSTONE

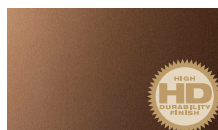

**FUSED BRONZE,
SEASTONE



**FUSED BRONZE,
DIAMOND

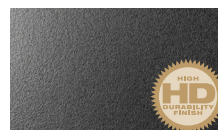

**FUSED NICKEL SILVER,
SANDSTONE



**FUSED NICKEL SILVER,
SEASTONE

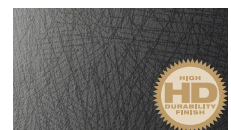

**FUSED NICKEL SILVER,
DIAMOND

*Top opening, 10" and 7" diameter opening lids and 12-gallon concealed ash lid only.

**Fused Bronze and Fused Nickel Silver are available for 12-gallon configurations only.



UNIVERSAL LITTER & RECYCLING RECEPTACLE

PRODUCT DATA

BODY PATTERNS

The eight standard body patterns are shown in the 36-gallon, top-opening configuration. Not every body pattern is available in each body material and/or finish; see the Universal Receptacle Quote/Order Forms for available combinations.

ECO-ETCH PATTERNS*

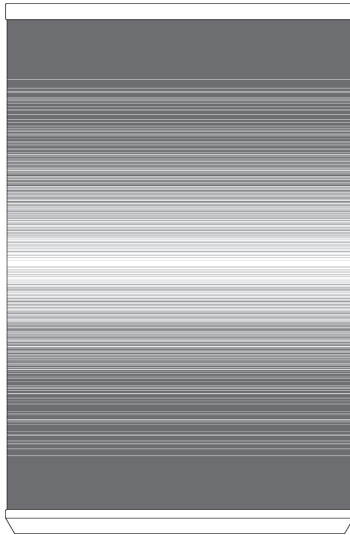

Horizon

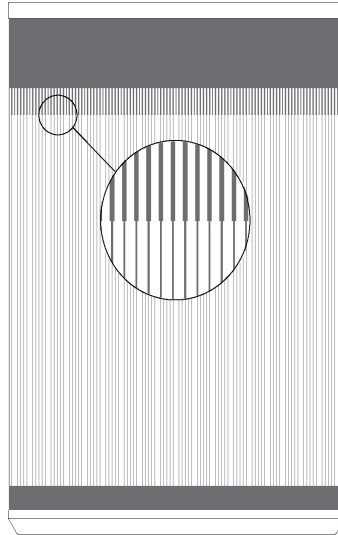

Pinstripe



Prism

*Eco-Etch patterns are shown with the etched areas in grey.

PERFORATION PATTERNS

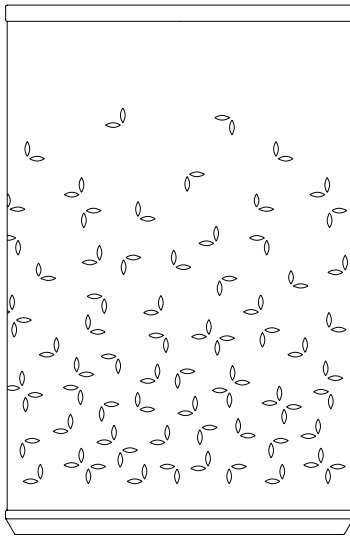

Fall

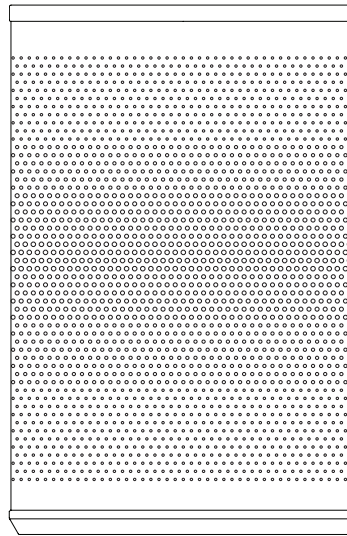

Fade

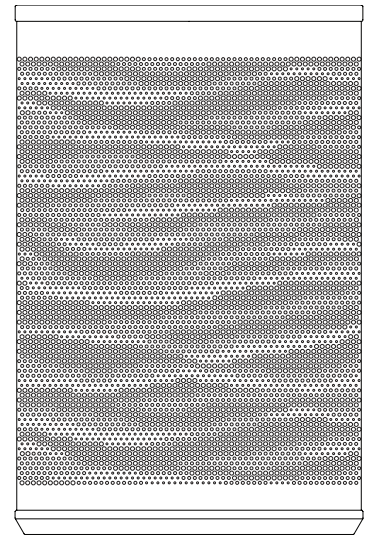

Scape



UNIVERSAL LITTER & RECYCLING RECEPTACLE

PRODUCT DATA

IMPRESSION PATTERNS*

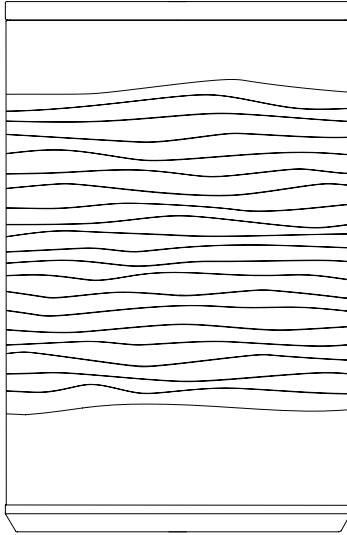

Dune

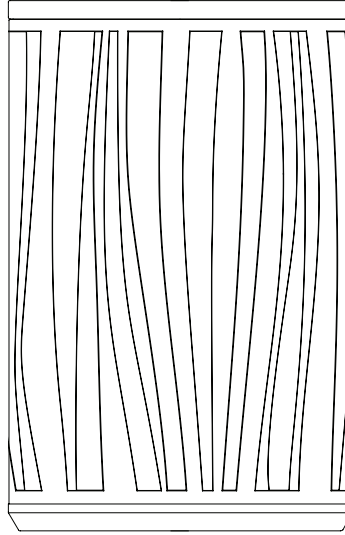

Canyon**

*Impression Patterns are not available for 12-gallon, side-opening models.

**Canyon Impression pattern is not available for 30-gallon receptacles.

ENVIRONMENTAL CONSIDERATIONS

- Please refer to the Universal Receptacle Environmental Data Sheet for detailed environmental impact information.
- Universal has a high recycled content.
- All components are fully recyclable.
- Low maintenance.



UNIVERSAL LITTER & RECYCLING RECEPTACLE

PRODUCT DATA

MODEL NUMBERS AND DESCRIPTIONS

MODEL	DESCRIPTION
SLUNN-36T10	Universal Receptacle, 36-gallon, top opening, 10" diameter opening; polyethylene lid or stainless steel lid
SLUNN-36T6	Universal Receptacle, 36-gallon, top opening, 6" diameter opening, polyethylene lid
SLUNN-36TP	Universal Receptacle, 36-gallon, top opening, paper slot, polyethylene lid
SLUNN-36TS	Universal Receptacle, 36-gallon, top opening, split-stream, polyethylene lid
SLUNN-36TT	Universal Receptacle, 36-gallon, top opening, tri-stream, polyethylene lid
SLUNN-36SSS	Universal Receptacle, 36-gallon, side opening, standard opening / standard opening, polyethylene lid
SLUNN-36SSR	Universal Receptacle, 36-gallon, side opening, standard opening / round opening, polyethylene lid
SLUNN-36SRR	Universal Receptacle, 36-gallon, side opening, round opening / round opening, polyethylene lid
SLUNN-30SSS	Universal Receptacle, 30-gallon, side opening, standard opening / standard opening, stainless steel lid
SLUNN-30SSR	Universal Receptacle, 30-gallon, side opening, standard opening / round opening, stainless steel lid
SLUNN-30SRR	Universal Receptacle, 30-gallon, side opening, round opening / round opening, stainless steel lid
SLUNN-24T10	Universal Receptacle, 24-gallon, top opening, 10" diameter opening; polyethylene lid or stainless steel lid
SLUNN-24T6	Universal Receptacle, 24-gallon, top opening, 6" diameter opening, polyethylene lid
SLUNN-24TP	Universal Receptacle, 24-gallon, top opening, paper slot, polyethylene lid
SLUNN-24TSS	Universal Receptacle, 24-gallon, top opening, split-stream, polyethylene lid
SLUNN-24SSS	Universal Receptacle, 24-gallon, side opening, standard opening / standard opening, polyethylene lid
SLUNN-24SSR	Universal Receptacle, 24-gallon, side opening, standard opening / round opening, polyethylene lid
SLUNN-24SRR	Universal Receptacle, 24-gallon, side opening, round opening / round opening, polyethylene lid
SLUNN-12T7	Universal Receptacle, 12-gallon, top opening, 7" diameter opening; polyethylene lid or stainless steel lid
SLUNN-12TSS	Universal Receptacle, 12-gallon, top opening, split-stream, polyethylene lid
SLUNN-12SD	Universal Receptacle, 12-gallon, side opening, dome lid, polyethylene lid
SLUNN-12SA	Universal Receptacle, 12-gallon, side opening, stainless steel concealed ash lid

PRODUCT OPTIONS

The following options are available for an upcharge

Upgrade from one full liner to two half liners and internal baffle for side opening receptacles	Add standard body pattern
Upgrade from polyethylene lid to stainless steel lid (top opening, 10" and 7" dia. opening only)	Add tether cable to connect lid to receptacle's body
Upgrade from stainless steel to Fused Metal body (12 gallon receptacles only)	Upgrade from polyethylene base to TENSU UHPC base

TO ORDER SPECIFY: Quantity, model, lid material, lid graphics, body material and finish, body pattern, base material, freestanding or surface mount, bag straps, drain holes, and lid tether.

NOTE: Because different computers will render colors and textures differently, actual colors and finishes may vary slightly from those shown here.